



INSTALLATION INSTRUCTIONS

WINCH MOUNT KIT

Part Number: 101255

Application: 2018 - 2021 Jeep Wrangler JL Rubicon

GENERAL SAFETY PRECAUTIONS

Your safety, and the safety of others, is very important. To help you make informed decisions about safety, we have provided installation and operating instructions and other information on labels and in this guide. This information alerts you to potential hazards that could hurt you or others. It is not possible to warn you about all potential hazards associated with this product, you must use your own good judgment.

CARELESS INSTALLATION AND OPERATION CAN RESULT IN SERIOUS INJURY OR EQUIPMENT DAMAGE. READ AND UNDERSTAND ALL SAFETY PRECAUTIONS AND OPERATING INSTRUCTIONS BEFORE INSTALLING AND OPERATING THIS PRODUCT.

This guide identifies potential hazards and has important safety messages that help you and others avoid personal injury or death. WARNING and CAUTION are signal words that identify the level of hazard. These signal words mean:

▲WARNING signals a hazard that could cause serious injury or death, if you do not follow recommendations. ▲CAUTION signals a hazard that may cause minor to moderate injury, if you do not follow recommendations.

This guide uses NOTICE to call attention to important mechanical information, and Note: to emphasize general information worthy of special attention.

▲ WARNING

IMPACT AND MOVING PARTS ENTANGLEMENT HAZARD

Failure to observe these instructions could lead to severe injury or death

- **Always** take time to fully read the Instructions and/or Operations Guide, and/or Basic Guide to Winching Techniques, in order to understand your winch and its operations.
- **Always** use extreme caution when drilling on any vehicle. Make sure that all fuel lines, brake lines, electrical wires, and other objects are not punctured or damaged when/if drilling on the vehicle. Thoroughly inspect the area to be drilled (on both sides of material) prior to drilling, and relocate any objects that may be damaged. Failure to inspect the area to be drilled may result in vehicle damage, electrical shock, fire or personal injury.
- **Always** wear safety glasses when installing this kit. A drilling operation will cause flying metal chips. Flying chips can cause eye injury.
- **Always** use extreme caution when cutting and trimming during fitting.
- **Always** remove jewelry and wear eye protection.
- **Never** lean over battery while making connections.
- **Never** route electrical cables:
 - o Across any sharp edges.
 - o Through or near moving parts.
 - o Near parts that become hot.
- **Always** insulate and protect all exposed wiring and electrical terminals.
- **Always** install terminal boots as directed in installation instructions.
- **Always** use appropriate and adequate care in lifting components into place.
- **Always** insure components will remain secure during installation and operation.
- **Always** tighten all nuts and bolts securely, per the installation instructions.
- **Always** perform regular inspections and maintenance on the plow mechanism, fasteners, cable and related hardware.
- **Always** replace all worn or damaged parts before operating.
- **Never** operate this WARN product with damaged or missing parts.

Read installation and operating instructions thoroughly.

WARN INDUSTRIES, INC. 12900 S.E. Capps Road,
Clackamas, OR USA 97015-8903, 1-503-722-1200, FAX: 1-503-722-3000
Customer Service: 1-800-543-9276
Dealer Locator Service: 1-800-910-1122
International Fax: 1-503-722-3005

⚠ CAUTION

MOVING PARTS ENTANGLEMENT HAZARD

Failure to observe these instructions could lead to minor or moderate injury

- **Always** take time to fully read and understand the installation and Operations Guide included with this product.
- **Never** operate this product if you are under 16 years of age.
- **Never** operate this product when under the influence of drugs, alcohol or medications.

Read installation and operating instructions thoroughly.

NOTICE

EQUIPMENT DAMAGE

- **Never** tow vehicle by attaching a tow bar to the eyelets on the bumper.
- **Never** attach tow bars directly to the bumper. Damage to bumper may occur. WARN bumpers are not designed to be used for flat towing. Consult with the manufacturer of your tow bar system for the proper vehicle tow bar brackets.

Read installation and operating instructions thoroughly.

TABLE OF CONTENTS

Tools Required.....	page 2
Torque Specifications.....	page 2
Parts List.....	page 3
Installation	page 4-11
Maintenance/Care.....	page 11

TOOLS REQUIRED

- Standard wrenches
- Standard sockets
- Hacksaw Blade with Handle (*fine tooth*)

TORQUE SPECIFICATIONS

Please use the recommended torque specifications when assembling this product unless otherwise specified in the instructions.

FASTENER SIZE	FASTENER TORQUE		FASTENER SIZE	FASTENER TORQUE	
	lb-ft	(N.m)		lb-ft	(N.m)
1/4"	8	(11)	M4	(2)	3
5/16"	17	(23)	M5	(4.5)	6
3/8"	30	(40)	M6	(7.5)	10
7/16"	48	(66)	M8	(18)	25
1/2"	74	(100)	M10	(37)	50
9/16"	106	(144)			
5/8"	148	(200)			
3/4"	269	(364)			

PARTS LIST

ID No.	PART NO.	QTY	Description
A1	101251	1	WINCH PLATE
A2	101304	1	LH WINCH PLATE BRACKET
A3	101303	1	RH WINCH PLATE BRACKET
A4	101305	2	WINCH PLATE SPACER
A5	101256	1	FILLER PLATE
B1	81707	4	M10 X 1.5 X 40 CARRIAGE BOLT
B2	87166	4	M10 X 1.5 FLANGE ELASTIC NUT
B3	79146	5	M8 X 1.25 HEX FLANGE NUT (<i>not shown</i>)

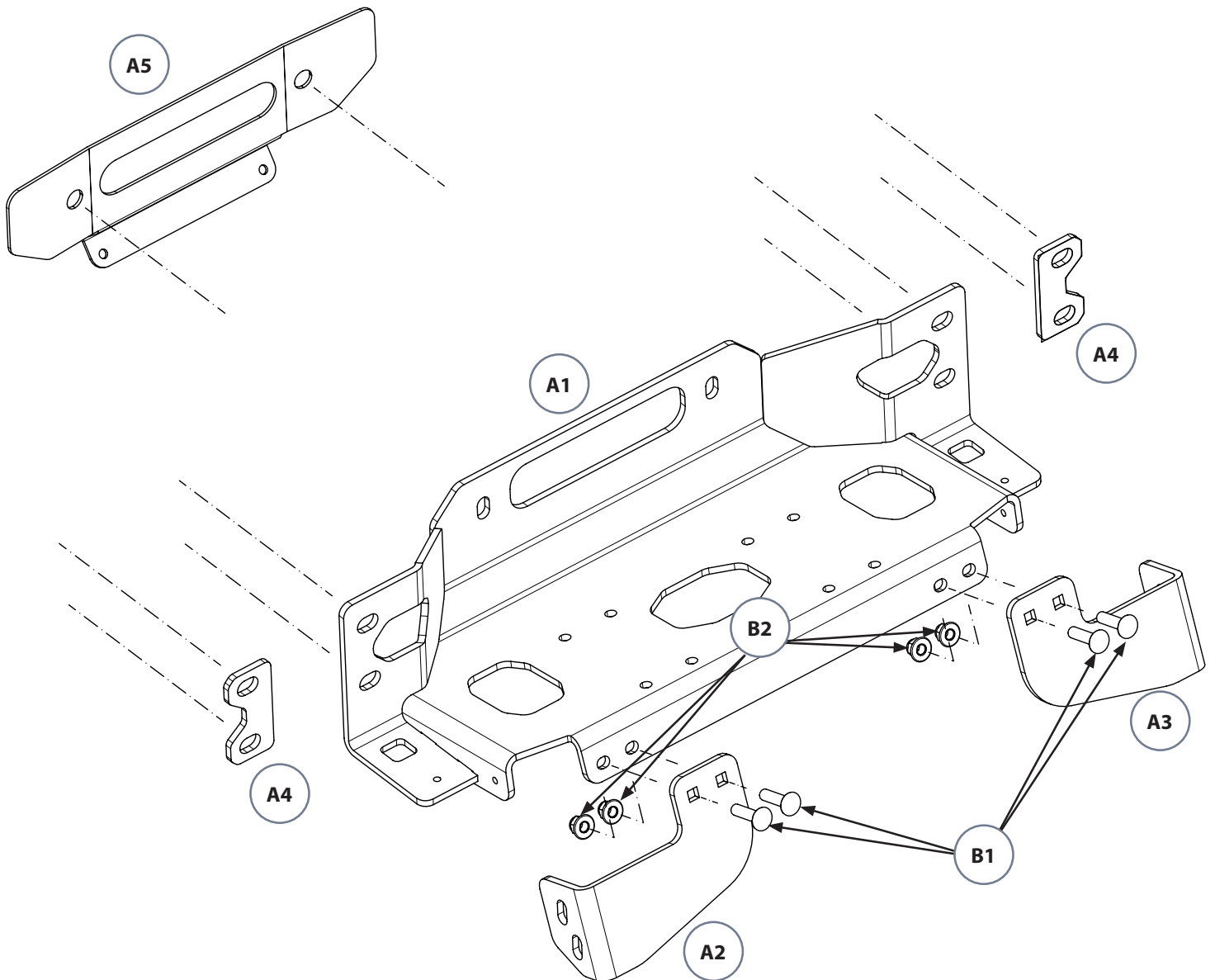

INSTALLATION INSTRUCTIONS



Figure 1

1. Remove fascia plate, located behind the bumper, by using a small screwdriver to pry the two clips (one on each side) up and out of plate. **NOTE: You will not be reinstalling fascia plate.**



Figure 2

2. Using a 13mm socket, remove bolts securing skid plate to bumper and frame.

Once all bolts (7 total) are removed, remove skid plate completely. **NOTE: Retain hardware for when the skid plate is reinstalled.**



Figure 3

INSTALLATION INSTRUCTIONS

3. Disconnect the fog light wire harness, located along the frame rail on the passenger side of the vehicle.



Figure 4

4. Use an 18mm socket to remove the nuts (8 total) from the OE bumper .
 - a. From the outside of the bumper, remove the two nuts (both sides).

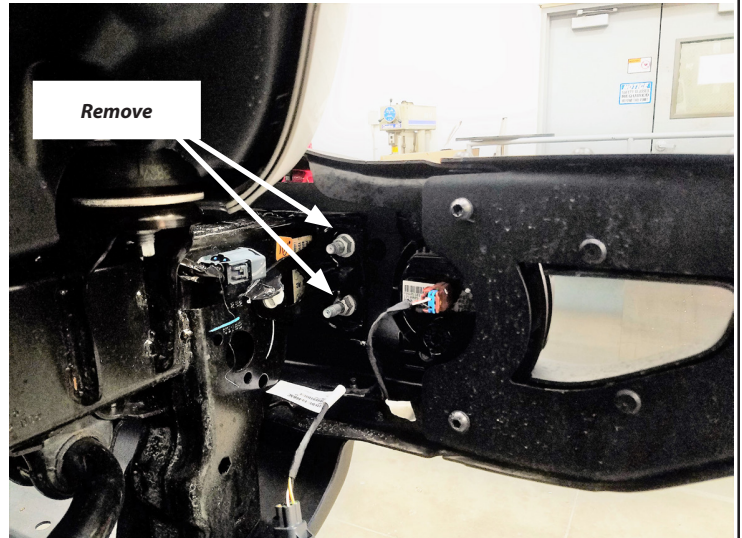

Figure 5

- b. From the inside of the frame, remove the two nuts (both sides).
5. Remove the frame horn bolt holding the inner frame support gussets and remove the gusset. **NOTE: The gussets and hardware will not be reused.**

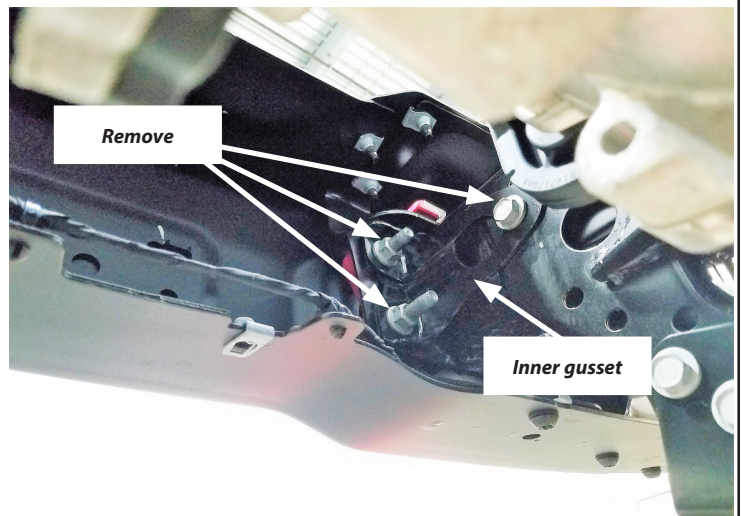

Figure 6

CAUTION

- Always use assistance when moving or lifting heavy parts.

6. Carefully remove the bumper and place it on a clean stable surface.
7. Using a T45 Torx driver, un-install the cover plate by removing the five bolts attaching it to the bumper.

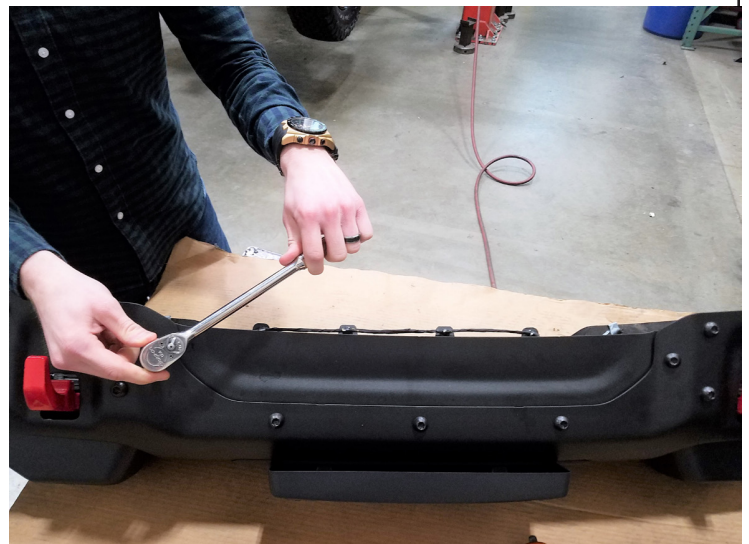

Figure 7

8. With cover off, use the supplied M8 x 1.25mm hex nuts and the five T45 Torx head bolts (just removed) and reinstall back into the bumper. *This step is for cosmetic purposes only.*



Figure 8

9. Remove the license plate and license plate cover.



Figure 9

10. Remove license plate holder and fascia plate by pressing the six clips and pressing the plate forward.



Figure 10

11. Use a small flat head screwdriver to pry wire harness clips upward.
12. Disconnect fog light harness Christmas tree clips from the bumper. **NOTE: The wire will hang loosely, but will later be secured to winch plate.**

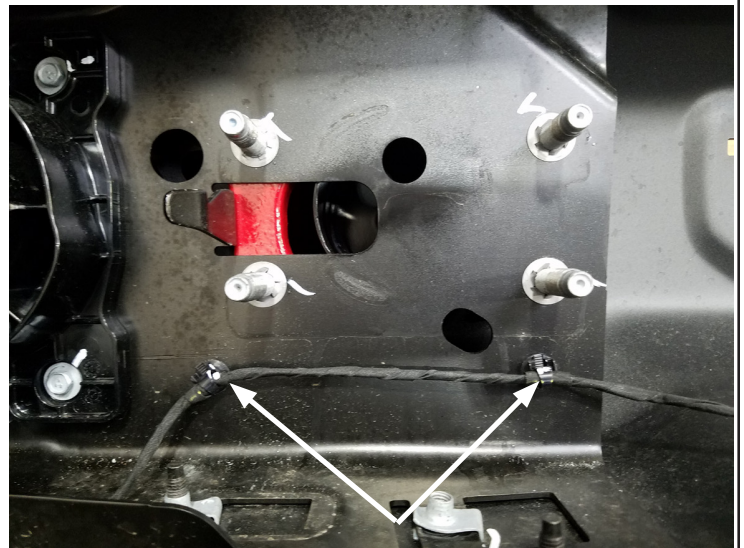

Figure 11

13. Remove the four bolts (two on each side) that attach the two skid plate mounting brackets to the frame. **NOTE: Retain hardware and brackets for winch plate bracket installation.**

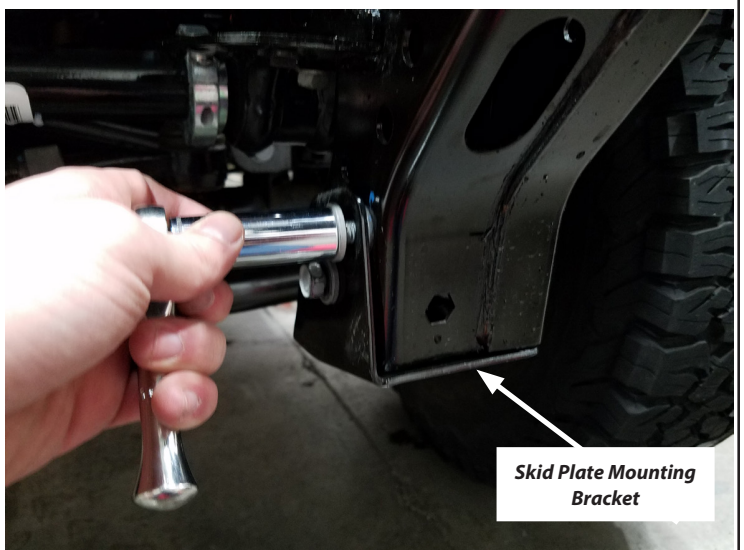

Figure 12

14. Install the left and right winch plate brackets and the skid plate mounting brackets back to vehicle frame, using hardware removed in previous step. **Do not fully tighten the hardware at this time.**

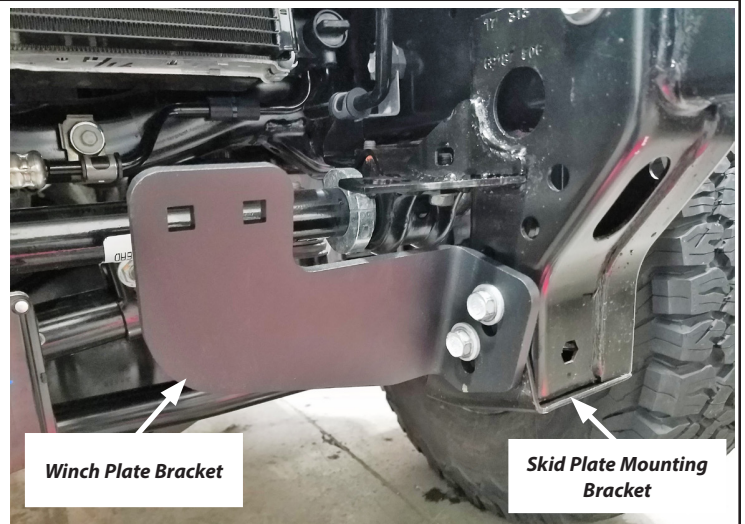

Figure 13

15. Install the winch plate onto the winch plate brackets using the supplied M10x1.5 carriage bolts and hex nuts. **Do not fully tighten the fasteners at this time.**



Figure 14

16. Thread the supplied zip ties through the indicated holes on the wings of the winch plate and through the frame. Start the zip tie, but do not fully tighten it.

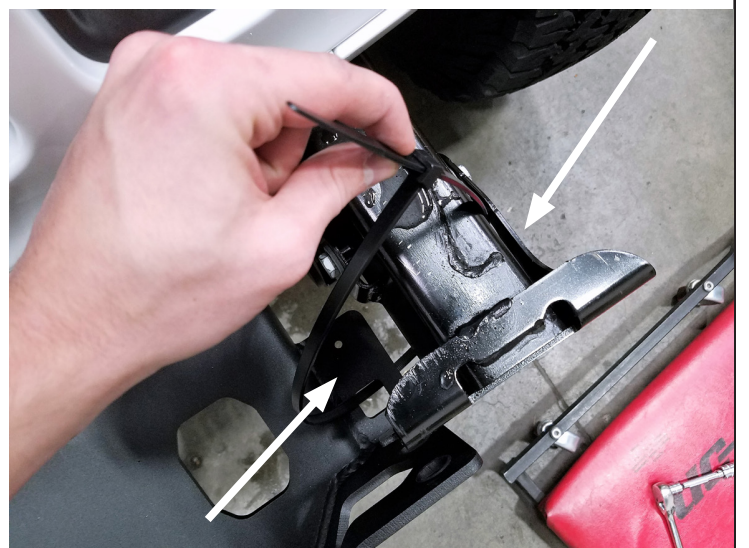

Figure 15

17. Lift the front of the winch plate until the mounting holes are aligned between the winch plate and the frame rails. **Tighten the zip ties to hold the plate in this location.**



Figure 16

18. Mount your winch onto the winch plate using the hardware supplied in your winch kit.
19. Refer to the winch specific install torque specifications to fully tighten the hardware.
20. Disengage the winch and spool out approximately 1 foot of winch rope.
21. Check mounting hole alignment. Once confirmed, tighten zip ties, in order to keep the holes aligned while mounting. Trim off excess of zip tie.



Figure 17

22. Place which plate spacers onto each of the outer sets of studs on the bumper.

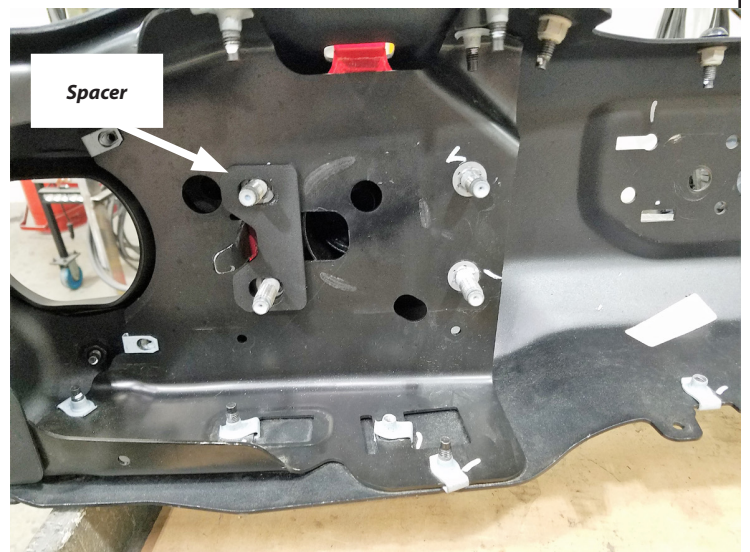

Figure 18

⚠ CAUTION

- Always use assistance when moving or lifting heavy parts.

23. With assistance, reinstall the front bumper using stock factory nuts at the eight mounting points in the frame. Be sure to feed the winch rope through the fairlead opening in the bumper. Torque the hardware to meet Jeep factory specifications.



Figure 19

24. Thread the winch rope through the filler plate and fairlead. Secure plate and fairlead to bumper using the hardware supplied in the winch kit. Fully tighten all hardware per fairlead install specifications.

25. Install the license plate onto the flange on the fairlead filler plate.

26. Install hook to winch rope.

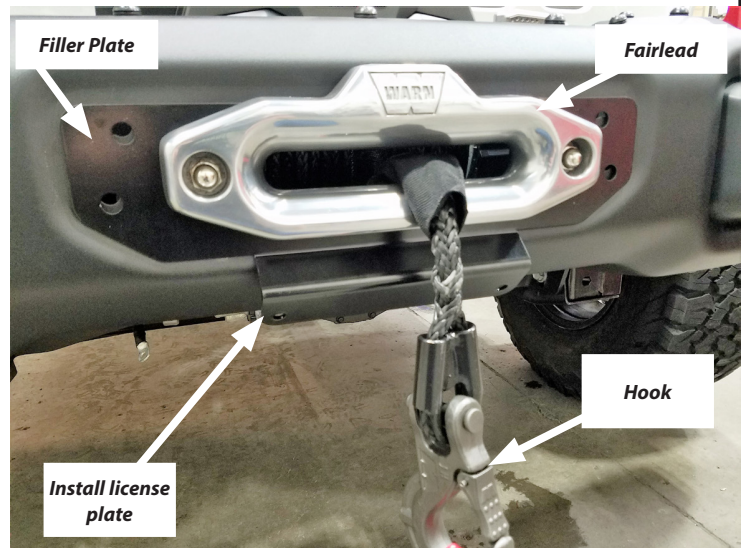

Figure 20

27. Secure the fog light wire harness to the winch plate using the exposed christmas tree clips.

28. Fully tighten the bolts attaching the winch plate brackets to the frame, as well as the hardware attaching the winch plate brackets to the winch plate.

29. Route the winch ground and power wires up to the battery. Make sure to keep the wires clear of any areas with extreme heat or any moving parts. Secure the cables with zip ties if necessary.

30. Reinstall the front skid plate using the factory hardware and fully tighten.

NOTE: Depending on fitment, some slotting of rear stock skid pan holes may be required.

31. Reconnect the plug for the fog light harness.



Figure 21

32. Installation has been completed.



Figure 22

MAINTENANCE / CARE

1. Inspect all parts on the winch, winch mount, and related hardware prior to each use. Replace all hardware that appears rusted or deformed.
2. Inspect all nuts and bolts on the winch, winch mount and related hardware prior to each use. Tighten all nuts that appear to be loose. Stripped, fractured, or bent bolts or nuts need to be replaced.
3. Check all cables prior to use. Replace cables that look worn or frayed.
4. Check all moving or rotating parts. Remove debris that may inhibit the part from moving freely.